

Apple logo & App Store are trademarks of Apple Inc., Google logo and Google Play are trademarks of Google Inc.



**service@azdome.hk**

Response in just 12 hours

# User Manual

## M63 Lite

Please scan the QR code to contact us on WhatsApp.

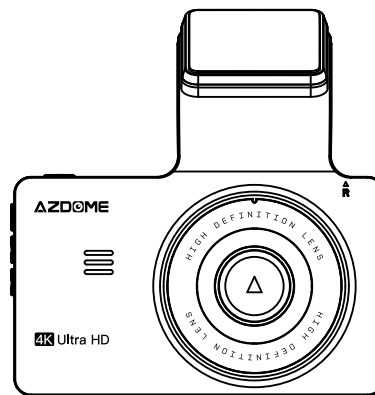
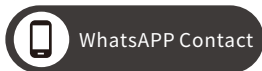

**Product** | Car Dashcam  
**Manufacturer** | Lingdu Co., Ltd.  
**Address** | 1801-1808, HaiYun Building, No. 468, Minzhi Avenue,  
Longhua New District, Shenzhen, China. 518000  
**Product Warranty** | One-Year Limited Warranty  
**Customer Support** | service@azdome.hk  
**www.azdomes.com**



FCC ID: 2ASWVM63

**AZDOME**

www.azdomes.com

Enjoy Your Smart Driving

## INDEX

---

1. WARRANTY & CUSTOMER SUPPORT .....	2
2. PRODUCT SEPCIFICATION. ....	3
3. PRODUCT DIAGRAM. ....	4
4. KEYS AND FUNCTIONS .....	7
5. LED STATUS LIGHT INDICATOR .....	8
6. INSTALLATION .....	8
7. GET STARTED .....	12
8. MODE (VIDEO/PLAYBACK) SETTING.....	13
9.WIFI. ....	18
10. FIRMWARE UPDATE.....	22
11. READING DASHCAM FILES.....	24
12. FAQ .....	25
13. Notice .....	27

## » WARRANTY & CUSTOMER SUPPORT

Thank you for purchasing this AZDOME dashcam.

This instruction manual contains information on how to operate your dash cam. Before using your dashcam, we recommend that you read through this manual to ensure correct usage.

To improve the performance of the product, the contents of this manual are subject to change without prior notice.

### Note:

1. **A U3 type microSD card (Not included)** is required to use this Dash Cam. Be sure to format your microSD card with your dash cam for the first time use.
2. Please ALWAYS connect with power when using. As it is built in Super Capacitor (Only has a 1mAh Lithium Metal Battery used to memorize time).



[service@azdome.hk](mailto:service@azdome.hk)

Scan QR code to download Manual



## » PRODUCT SEPCIFICATION

Model	M63 Lite
Screen	3.0 inch IPS screen
Aperture	F=1.8
Color	Black
Language	English, French, Spanish, Portuguese, German, Italian, Japanese, Simplified Chinese, Traditional Chinese, Russian, Polish
Photo Resolution	12M 4032*3024    8M 3264*2448 5M 2592*1944    2M 1600*1200
Video Resolution	4K 2880x2160 (Default) 2K 2560x1440
WiFi	Support, please download APP "AZDOME"
Video Format	MP4
Photo Format	JPG
Mic-phone	Support
Speaker	Support
USB Port	Power Supply, Mini USB cable
Power Interface	5V/2.5A
Working Temperature	-20°C~ +70°C

## » PRODUCT DIAGRAM

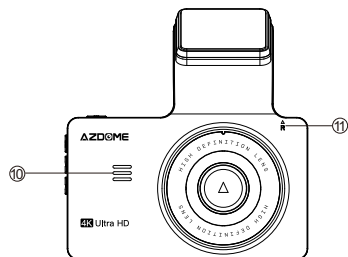
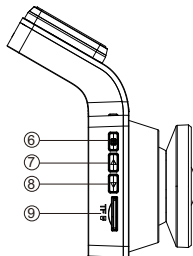
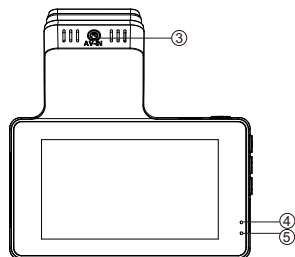
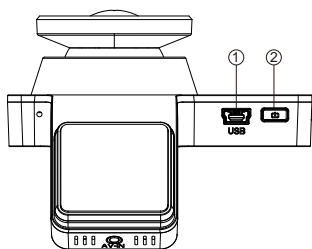

① Mini USB

③ Rear Camera Slot (AV-IN)

⑤ Charging LED Indicator

⑦ UP

⑨ Micro SD Card Slot

⑪ Reset

② Power/OK

④ Recording LED Indicator

⑥ Menu

⑧ Down

⑩ Speaker

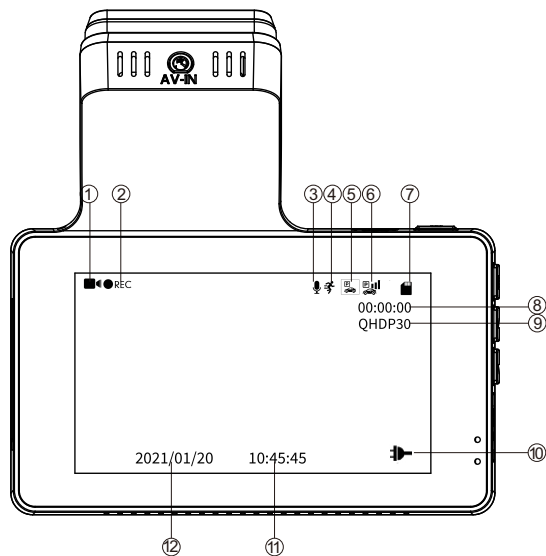

① Video Mode

② Recording Indicator

③ Audio Recording Indicator

④ Motion Detection

⑤ Parking Mode

⑦ Micro SD Card

⑧ Loop Recording Time(When recording) / Micro SD Card Remaining Time of Recording (When NOT recording)

⑨ Video Resolution

⑩ Battery Indicator

⑪ ⑫ Date/Time

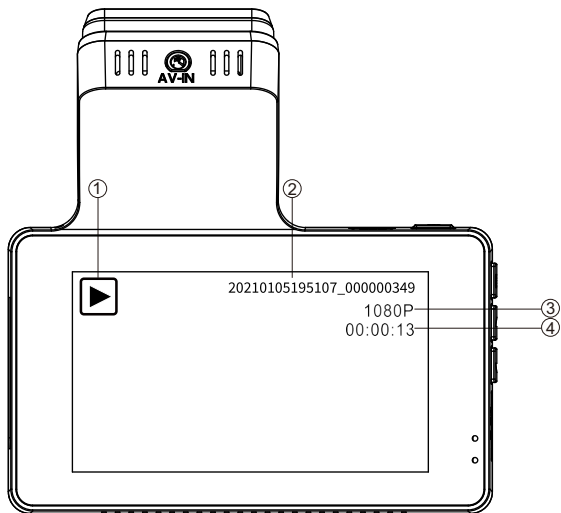

① Playback Mode

② Video File Name

③ Video Resolution

④ Video Date/Time

## •» KEYS AND FUNCTIONS

Button Image	Button Name	Instruction
	POWER / OK	<ol style="list-style-type: none"> <li>1.To Turn ON The Camera: Press power button once.</li> <li>2.To Turn OFF The Camera: Press and hold power button for 2-seconds.</li> <li>3.Press Once - to start/stop video recording</li> <li>4.Press Once - to playback/pause the video while in Playback Mode</li> <li>5.Press Once - to enter / confirm specific settings while in Menu Settings</li> <li>6.Press Once - to awake screen while on screen saver function.</li> </ol>
	RESET	All settings will be restored to factory settings.
	MENU / MODE	<p>Press Once - to enter/exit menu settings</p> <p>Press and hold for 2-Seconds - to switch Modes (Video/ Playback)</p>
	UP	<ol style="list-style-type: none"> <li>1.Press Once - to scroll up while in any Menu Settings</li> <li>2.Press Once - switch front and rear camera on Video Mode or recording</li> <li>3.Press Once - to scroll to previous video files while in Playback Mode</li> <li>4.Press and hold for 2-Seconds - to turn on WiFi on Video Mode</li> </ol>
	DOWN	<ol style="list-style-type: none"> <li>1.Press Once - to scroll down while in Any Menu Settings</li> <li>2.Press Once - to enable/un-enable audio recording when recording</li> <li>3.Press Once - to scroll to next video files while in Playback Mode</li> <li>4.Press and hold for 2-Seconds - to lock current video file</li> </ol>

## »» LED STATUS LIGHT INDICATOR

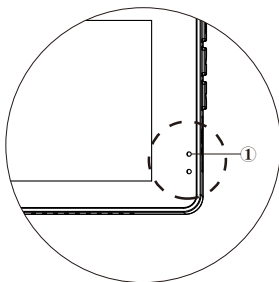

1 Blue LED	Blinking	Camera is recording
1 Blue LED	Blinking rapidly	Updating firmware

## »» INSTALLATION

### Insert Micro SD Card

1. Make sure the dash cam is turned OFF.
2. Insert the Micro-SD Card half way in ( GOLD Contacts - Back the Lens Side)
3. Now gently push the card in until it clicks & looks in place.
4. Must use only Brand Name, Class-10, U3 or higher speed Micro-SD Card.

### Remove Micro SD Card

-To remove the Micro SD card, gently push its top edge inward until it clicks, and then pops out, then simply pull it out of the slot.

#### **MOST IMPORTANT about Micro-SD Card**

1. Do not remove or insert Micro-SD card when the camera is powered on which may damage the memory card.
2. You **MUST** Format the Micro-SD card in camera for the first time using.

### Installation

1. Stop the engine where there is some light and in a safe place, and then remove the key.
2. Make sure to clean your windshield from the dust particles and an evaporated grease from the dashboard surface.
3. Attach the Static Clings Sticker (it will leave no residue when removal is required) to the windshield. Peel off the protective film from the double-sided tape and attach the front camera to the Static clings sticker.

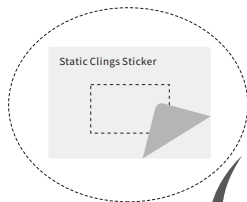

Remove the film of the Static Clings Sticker

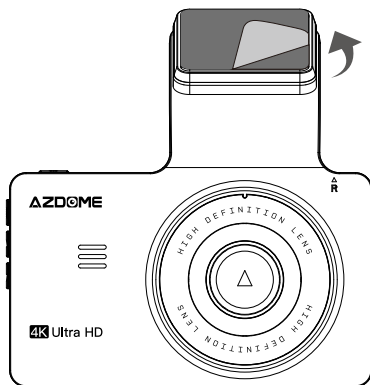
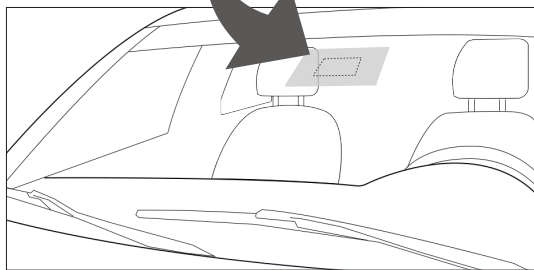

4. Insert the Micro SD card into the Micro SD slot of the dash cam.  
(Note: please use an A-Brand high-speed Micro SD card, class 10 or above)
5. Plug USB charger into your vehicle's cigarette lighter socket. Run the cable along your vehicles console and windscreen and plug it into the camera port marked with the USB icon.

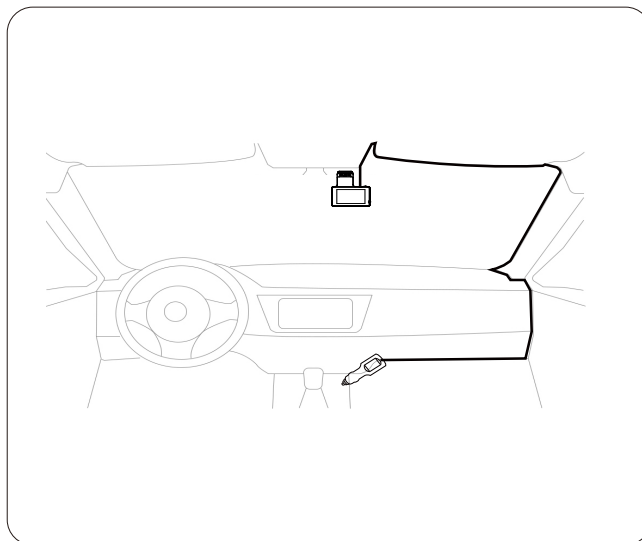

6. Use the cable clip to organize and hide the power cord so that it doesn't interfere with the driver's vision.

## •» GET STARTED

### Power On/Off

Option 1:

Start the engine to automatically power on the Dash Camera;

Stop the engine to automatically power it off.

Option 2:

Press power button once to turn on device;

Press and hold power button for 3 seconds to turn off device.

## •» MODE (VIDEO/PLAYBACK) SETTING

AZDOME dash cam has THREE different camera modes:



To shift mode: Prese OK to stop recording. Press and hold  for 2 seconds.

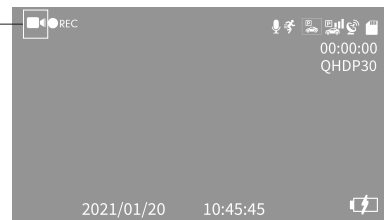

### Resolution

Front Camera:

4K 2880x2160 (Default)

2K 2560x1440

### Loop Recording — Off/ 1min/ 3mins(Default)/ 5mins

On: Here select the length(1/3/5 min) of each video clip for the loop recording. This function allows the dash cam to continuously record. Please notice: the dash cam will keep deleting the oldest files automatically when memory card gets full so that it can keep recording over and over.

Off: The dash cam will a long video until the card is full then stop to record.

### **WDR — On/ Off(Default)**

Wide Dynamic Range (WDR) processes images to ensure clear recordings in bright and dark light. This allows the Dash Cam to combine multiple images at different levels of brightness to create one superior image.

### **G-Sensor — Off/ High/ Medium(Default)/ Low**

G-sensor is a 3-axis impact gravitational accelerometer, designed to detect physical and gravitational forces on the dash cam. Once G-sensor has triggered due to physical or gravitational impact force on the camera, the current video file will be locked as an emergency file so it won't be deleted by loop cycle function.



#### **Note:**

1. If you want 24h monitoring, please use a 2-Lead Hardwire Kit to connect the dash cam to your car battery (Hardwire kit not included in the package).
2. Please ALWAYS connect with power when using. As it is built in Super Capacitor (Only has a 1mAh Lithium Metal Battery used to memorize time).

### **Record Audio — On(Default)/ Off**

The dash cam has built-in microphone to record audio with video. You can choose to record mute video by choosing OFF. You can also press  to mute/un-mute while video is being recorded.

### **Watermark — On(Default)/ Off**

Date/Time information will be shown on the videos when enabled.



### **WiFi— On/ Off(Default)**

On: The screen will display the name: M63\_Lite\_\*\*\*\*\* and its password: 12345678.

Please keep your phone close to the dash cam (within 3m) when using WiFi, you could control the dash cam and check the real-time video by AZDOME APP on your phone.

When enabled the dash cam won't response to your operation by pressing the buttons.

### **Time Setting**

Press  to select date format and hour/ minute/ second, then press  to save and exit.

### **Beep Sound — Off/On(Default)**

This feature allows you to turn ON/OFF camera button's beep sound & any voice confirmation.

### **Language — English(Default) and etc**

Allow to choose your desired language of dash cam system.

### **Frequency — 50HZ/ 60HZ(Default)**

To avoid the formation of bands while shooting videos under an electrical light source, Here you should choose the frequency accordingly to your power supply specification used in your country based on your geographical location.:50HZ-In the UK, Africa, Australia, most of Asia and Russia60HZ-North America, and a few other countries (Japan uses both)

### Backlight — Off(Default)/ 1 min/ 3 mins/ 5mins

On: the screen will go black and ONLY display the time after 1/3/5 minutes no-operation while the dash cam is still on/ recording (Blue lights flash), you could press any button to exit screen saver and back to normal interface.

### Storage Space

This feature will allow you to check the storage of inserted Micro SD card into the camera.

Total: (Micro SD Card Capacity)

Free: (Free Space of Micro SD card)

### Format

This feature will allow you to format inserted memory card all data will be delted.

### Default Setting

Here you can restore all the settings to factory default settings.

### Version

Here you can check the current firmware version installed on your camera.

You will need this information in the future to check if newer version of firmware is available.

Please visit: <https://www.azdomes.com/pages/support> for the latest firmware upgrade instructions.

Please NOTE:

Please ALWAYS connect with power when using. As it is built in Super Capacitor (Only has a 1mAh Lithium Metal Battery used to memorize time). If you want 24h monitoring, you can use one AZDOME2-Lead Hardwire Kit to connect the dash cam to your car battery (Hardwire kit not included in the package).



### Protect

This feature allows to lock/unlock the video & photo files on Micro SD card.

Lock All / Lock Current / Unlock All / Unlock Current

### Delete

This menu will allow you to delete current video or Delete All.

Delete Current (Delete current video file on LCD)

Delete All (CAUTION: This will Delete Entire Video & Photos from Micro SD card - Except the protected files)

## »» WIFI

### What is a WiFi Feature

The WiFi feature has been designed so you can pair your dash camera wirelessly with your smartphone and access your recording instantly from the dash cam. Here you can view, download and share your videos easily with your friends and family. Just like how you would connect your Bluetooth speaker to your smartphone for wireless music play, the same way dash cameras use WiFi signal (instead of a Bluetooth) to pair your smartphone with dashcam.

### Pairing Dashcam with your Smart Phone using WiFi

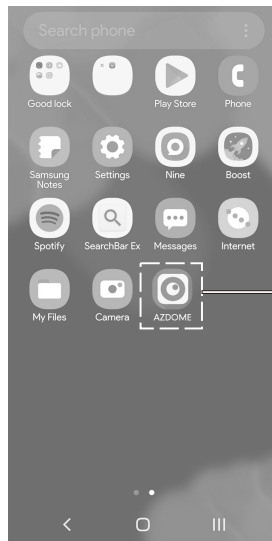

**1** Search for the AZDOME app in the Google Play Store or Apple App Store and install it on your smartphone.

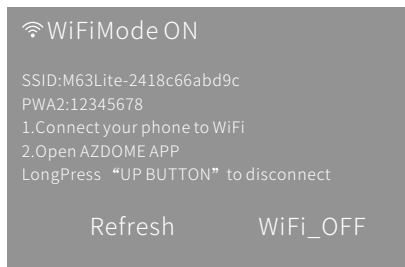

**2** Please ALWAYS connect to power supply. Press  button to turn on WiFi of dash cam.



**3** Go to your smartphone's Settings to turn on WiFi, then select WiFi default named "M63\_Lite \*\*\*\*\*", password is 12345678

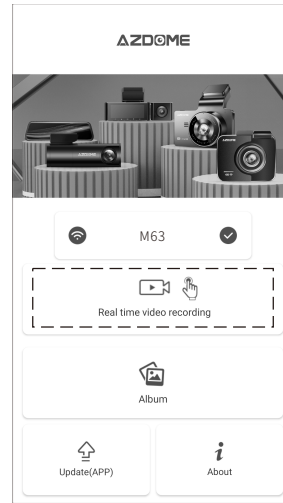

**4** There will show dash cam model M63 Lite when connected successfully, Touch "Check Real-time Video" to go into preview interface.

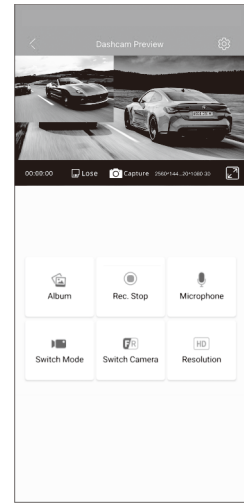

**5** You should see the live video feed from the camera on the AZDOME APP.

## NOTICE

- ① The WiFi signal range is about 10feet/3 meters when there are NO obstructions in the middle.
- ② If you can't get the live-video on APP, please turn off the 4G network of your phone or turn on Airplane Mode.
- ③ Please NOTE that just like your home WiFi network, you can't have WiFi signal outside your home.
- ④ Dash cam is NOT made to broadcast footage over the cloud or internet. It is NOT a cloud or an IP camera and it is NOT meant to do that.
- ⑤ You can't operate the dash cam when connecting WiFi. To disconnect WiFi, press and hold and hold  for 2-seconds to return to the video mode.

---

## •» FIRMWARE UPDATE

---

The firmware will be updated regularly to introduce new functions and improve the general performance. When the camera doesn't respond to your operation and the resetting doesn't help, it's useful to update to the latest firmware.

1. Please download the **M63 Lite** firmware file in

**[www.azdomes.com/pages/support](http://www.azdomes.com/pages/support)**

2. Please copy the firmware file named FW96670A.bin to the Micro-SD card and insert Micro SD Card into dash cam.

-DO NOT create any new folder on the Micro-SD card to save the firmware file. Simply copy and paste the file directly to the Micro-SD card.

-DO NOT change the firmware file name. Otherwise, the camera will NOT recognize the firmware update.

3. Connect to power supply and press power button to power on the dash cam, then the dash cam screen will stay black and the first Blue light

will blink rapidly for about 30-40 seconds. The dash cam will power on again when the firmware updating complete successfully.

4. Go to dash cam System Setting and select "Version" to check if the firmware version is the latest version.

5. MUST format the Micro SD Card in dash cam, otherwise the dash cam will update again when next power on.

Any problems please contact us **[service@azdome.hk](mailto:service@azdome.hk)**

## » READING DASHCAM FILES

1. Please remove the Micro SD card from camera and insert it directly in your laptop if you have a Micro SD Card slot (otherwise please using a Micro SD Card reader).

2. You should be able to see drive "D" or "E" or other name depending on the pre-installed hard drives. Once you find the added flash drive, double click in it, then you will see the Novatek- Movie / LOCK / Photo

Movie: The loop recording video files that can be overwritten.

LOCK: The video file will be locked so it will NOT be deleted by loop recording function.

3. Then simply double click on the video to play them.

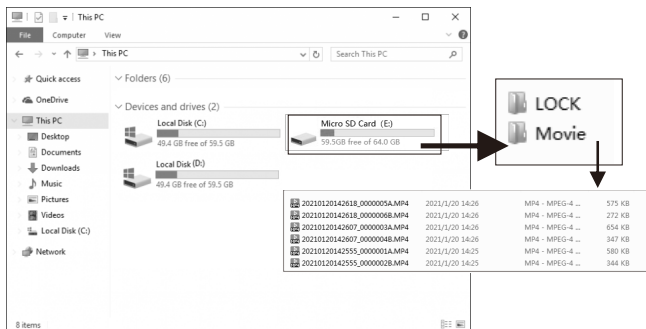

File named \*\*\*\*\*A=videos or photo captured by front camera

## » FAQ

Q: If the sticker mount is broken, what should I do

We prepare alternatives: one mount cover and one sticky pad in the package, please refer to directions below

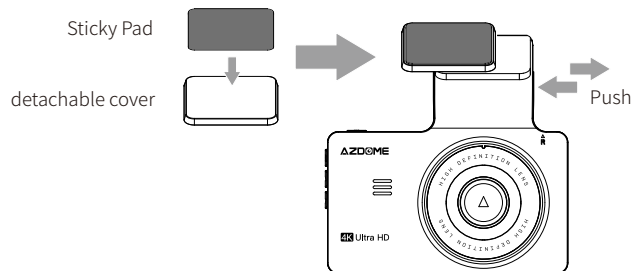

Q: I can't get live video on AZDOME APP, what should I do?

If can't get live-video on APP, please turn off cellular data of AZDOME APP, take iPhone and Google phone (Android 12) for example.

Technical Service: [service@azdome.hk](mailto:service@azdome.hk)



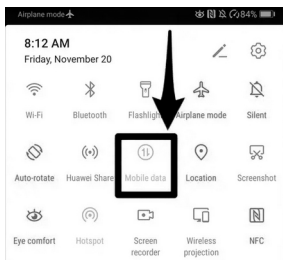

NOTE: It is normal that WiFi will say "No Internet Connection" because dashcam WiFi is ONLY for video/photo transfer function, NOT made to broadcast footage over the cloud or internet, please ignore the promot.

Q: Camera showing "Memory Error" or "Please Insert Micro SD Card" even though Micro SD card is already installed into the camera.

Please make sure Micro SD card is at least Class 10, U3 and purchased from trusted vendor such as Walmart, target, best buy, Ship & Sold by Amazon" etc. Go to camera's system settings and FORMAT your Micro SD card. (make sure to backup your videos first before formatting the Micro SD card.) After formatting Micro SD card, please press and hold power button to turn the camera off. Now unplug power cable, and re-plug the power cable, camera should now turn ON automatically and start recording. If still error please contact us.

Q: Camera Freezing/Lagging or Crashing.

If your camera is freezing, lagging or does NOT record video after some seconds etc. while operating: Then it is the Memory Card Issue. Either you are using the WRONG, FAKE or BAD Memory Card. (Please be aware of the Fake Ones out there. If you have purchased your memory card from eBay or any third party seller online then it is most likely a fake one, even though it looks exactly real. Please trust us. We have sold thousands of AZDOME Dash Camera's and they do NOT lag, we stand by our product and we do extensive

testing. Some customers simply think the camera is bad or not stable, but that is NOT the case here. It's the Memory Card Issue. Please CONTACT US and we are dedicated in resolving this for you ASAP.

Q: Video is fuzzy

Please make sure the lens of the camera is clean and there is no dirt or grease on the windshield also. If the lens is out of focus, we are extremely sorry in advance. This can be a manufacturing defect. Please send us an email with a screenshot or a sample video so we can get this resolved for you.

Q: Camera gets HOT

It is normal for your camera to run slightly hot. Working Temperature : -20°C~ +70°C

Q: My oldest video files are missing

AZDOME Dash Cam has function Loop Recording. When it is set to either 1, 3, 5-mins, it will delete oldest files and record newer files over and over when the memory card is full.

---

### •» Notice

CE This product complies with the radio interface requirements of the European Community.

 This symbol means the product must not be discarded as household waste, and should be delivered to an appropriate and recycling helps protect natural resources, human health and the environment. For more information on disposal and recycling of this product, contact your local municipality,

disposal service, or the shop where you bought this product.

**FCC** Changes or modifications not expressly approved by the party responsible for compliance could void the user's authority to operate the equipment.

This equipment has been tested and found to comply with the limits for a Class B digital device, pursuant to Part 15 of the FCC Rules. These limits are designed to provide reasonable protection against harmful interference in a residential installation. This equipment generates, uses and can radiate radio frequency energy and, if not installed and used in accordance with the instructions, may cause harmful interference to radio communications. However, there is no guarantee that interference will not occur in a particular installation.

If this equipment does cause harmful interference to radio or television reception, which can be determined by turning the equipment off and on, the user is encouraged to try to correct the interference by one or more of the following measures:

- Reorient or relocate the receiving antenna.
- Increase the separation between the equipment and receiver.
- Connect the equipment into an outlet on a circuit different from that to which the receiver is connected.
- Consult the dealer or an experienced radio/TV technician for help.

This device complies with Part 15 of the FCC Rules.

Operation is subject to the following two conditions: (1) this device may not cause harmful interference, and (2) this device must accept any interference received, including interference that may cause undesired operation.

This equipment complies with FCC radiation exposure limits set forth for an uncontrolled environment. This equipment should be installed and operated with a minimum distance of 20cm between the radiator & your body.

This transmitter must not be co-located or operating in conjunction with any other antenna or transmitter.